

1ºano

Português

Propostas de exercícios

**UMA FICHA
POR DIA
NEM SABES O
BEM QUE TE
FAZIA**

1 DATA ___/___/___



Eu sou a letra que se lê **ra, re, ri, ro, ru**. Completa de acordo com o que está feito.

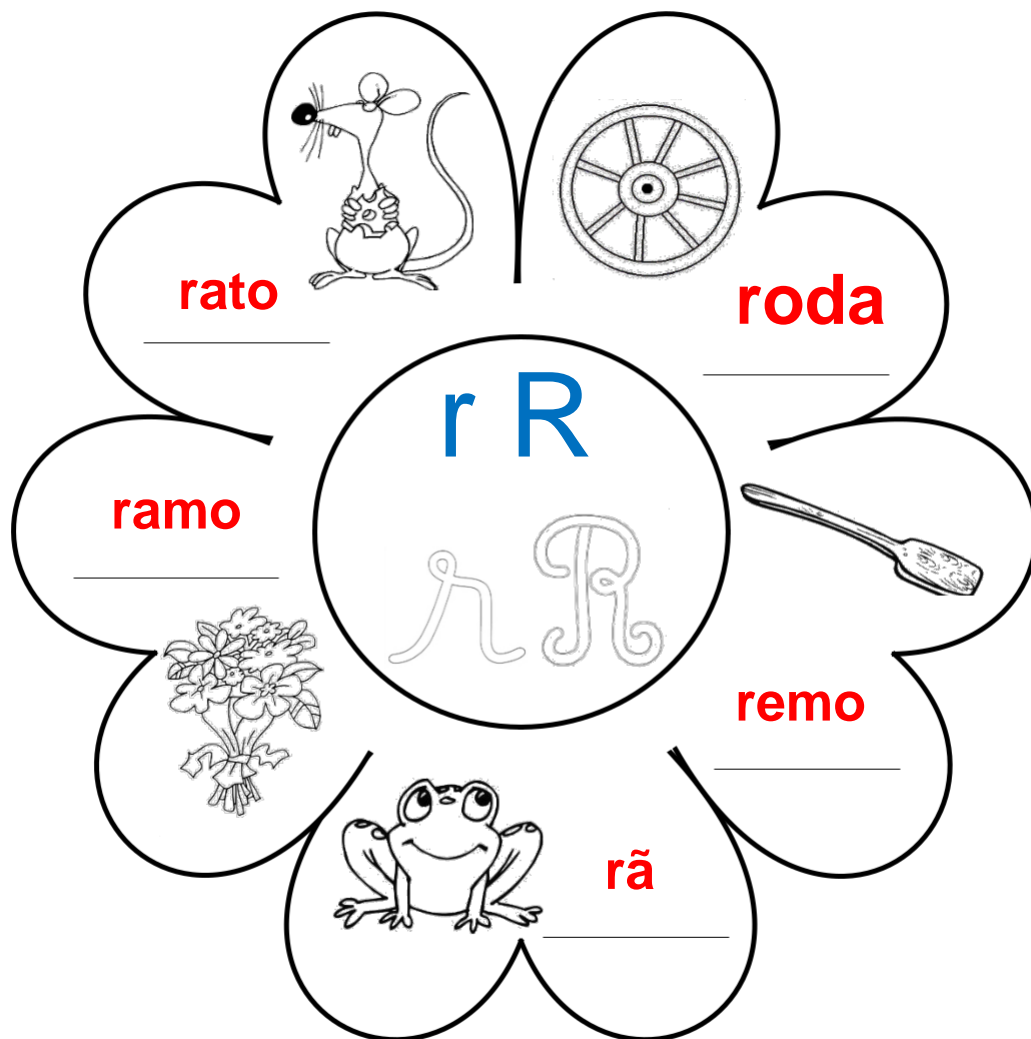

r

ra re ri ro ru

R

Ra Re Ri Ro Ru

2 DATA ___/___/___



É o rato.

É o rato.

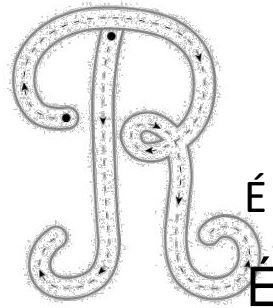

É o Rui.

É o Rui.

 Cópia.

r *r* _____

ra *ra* _____

re *re* _____

ri *ri* _____

ro *ro* _____

ru *ru* _____

R *R* _____

Ra *Ra* _____

Re *Re* _____

Ri *Ri* _____

Ro *Ro* _____

Ru *Ru* _____

 Completa conforme o exemplo.

	ra	re	ro	da	to	mo	la	
rato	X				X			rato
remo								_____
roda								_____
ramo								_____
rola								_____

 Escreve a frase completa.

O  roeu a  da  do  .

3 DATA ___/___/___

rádio

 Continua a letra **r**.

r _____

ri _____

ra _____

ro _____

re _____

ru _____

 Forma as frases.

rato O rói. ▶ _____

rei O é rico. ▶ _____

O Ruca rádio. ouve ▶ _____

 Ordena as sílabas e forma as palavras.

da

ro

to

ra

pa

rou

 Forma frases.

rato ▶ _____

roupa ▶ _____

roda _____

rádio _____

4 DATA ___/___/___

Ruca

Continua a letra **R**.

R

Ri

Ra

Ro

Re

Ru



Escreve as frases completas.

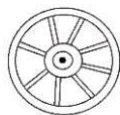

A _____ é do popó do Ruca.

A Rita dá o _____ à mãe.



O _____ é da Rute.



5 DATA ___/___/___



Ler e copiar.

O avô deu o rádio ao Rui.

– Viva avô, o rádio.

O Rui põe o rádio ao ouvido.

Ele ouve o relato todo.

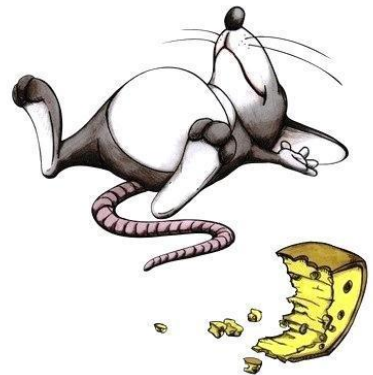



6 DATA ___/___/___



O rato comeu muito e caiu.





Escreve as frases completas.

O  roeu a  .

A mãe lavou a  toda.

O  é mau. Ele roeu a  da  .

A  caiu do  .



Ordena as palavras e escreve a frase.

Rui. A Rita tia é do _____ é roupa Rute. A da _____

7 DATA ___/___/___



É o Romão.



 Escreve as frases completas.

O  leva o  .

A  comeu a  ao pé do  .

O  vive ao pé do  .

O  vai à  e leva o  .

O avô Vilela deu o  à avó Rute.

 Ordena as palavras e escreve a frase.

a Ruca levou rede O _____ ouve O rádio rato _____

8 DATA ___/___/___



Escreve as palavras.



Lê a lengalenga. Rodeia o "r". Memoriza.

É a rua da Rita.
A Rita viu o rato.
O rato roeu a
roda.

A roda rolou pela rua.
Rolou e caiu ao rio.
A Rita riu, riu, riu...



Escreve as frases da lengalenga, de acordo com os desenhos.

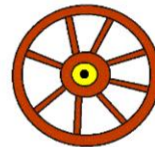
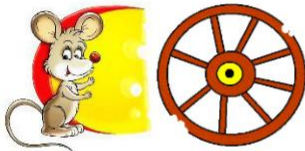

9 DATA ___/___/___



Eu sou a letra que se lê **ba, be, bi, bo, bu**. Completa.

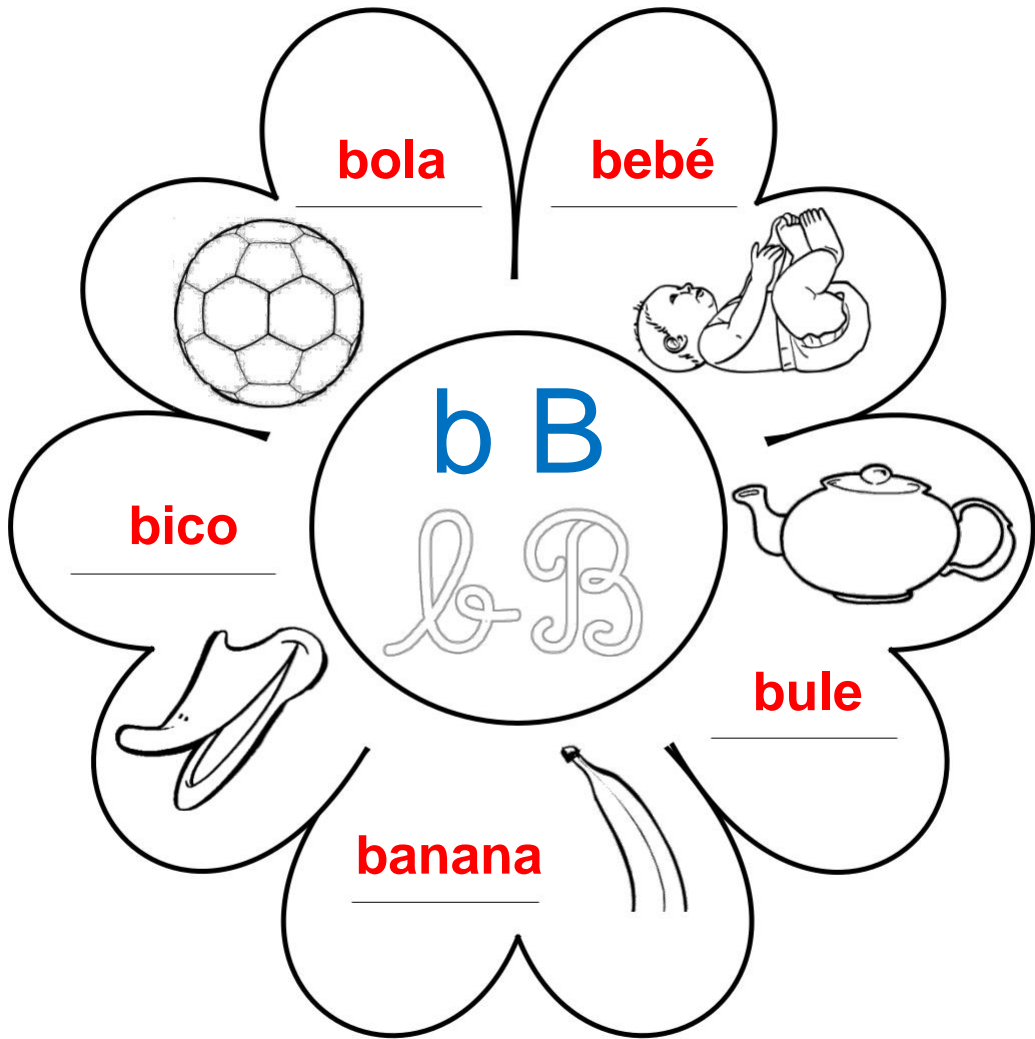

b

ba be bi bo bu

B

Ba Be Bi Bo Bu

10 DATA ___/___/___

ba be bi bo bu

B

Ba Be Bi Bo Bu



Ordena as palavras e ilustra uma das frases.

a do É bota bebé.



Beto come O banana. de bolo

11 DATA ___/___/___

bebé

 Continua a letra **b**.

b

b

 Escreve o nome das figuras.

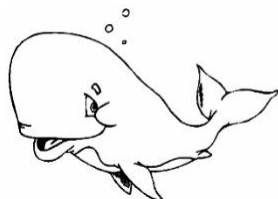

 Continua a letra **B**.

B

B

 Lê e copia o texto.

É a Bela. Ela é muito bonita.
A Bela come o bolo e bebe o batido.



12 DATA ___/___/___

Pinta todas as letras b de



todas as letras d de

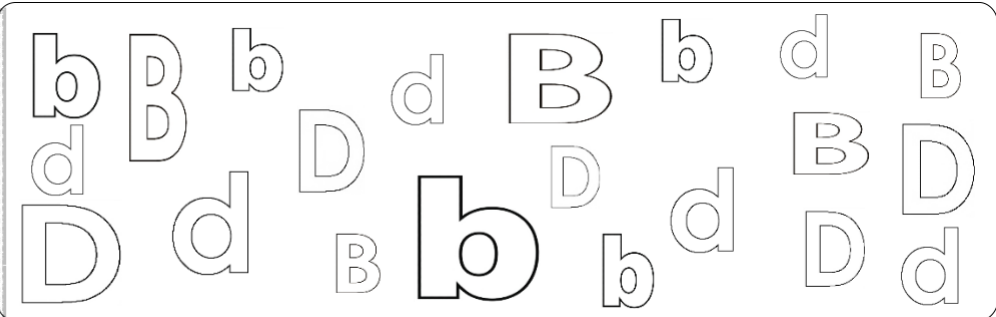
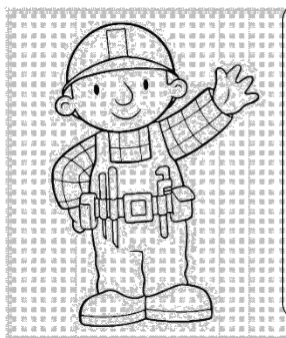

Escreve uma frase com as palavras.

A bebe o Bela batido.



Pinta as figuras em cujos nomes ouves b.

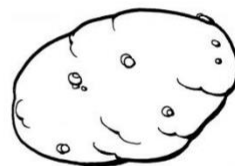
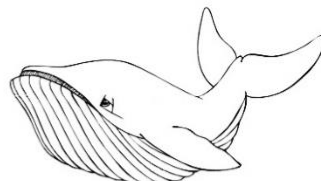
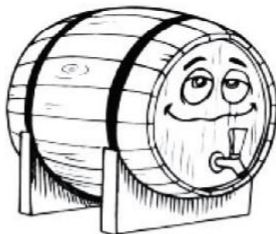

13 DATA ___/___/___



Escreve as palavras que correspondem às imagens. Pinta.

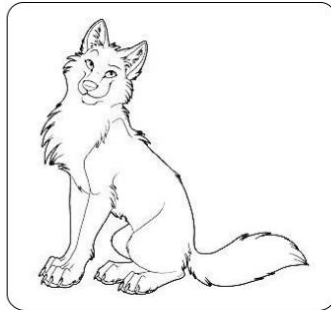
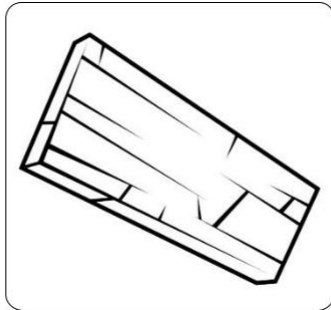
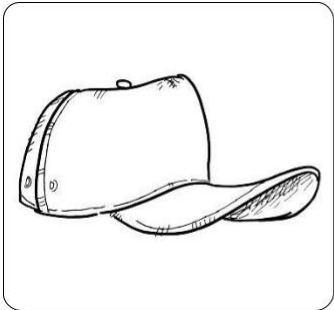
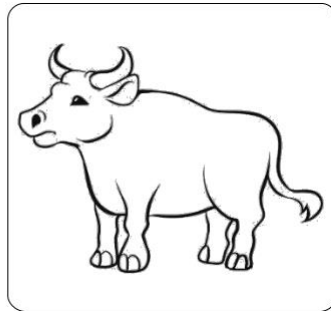
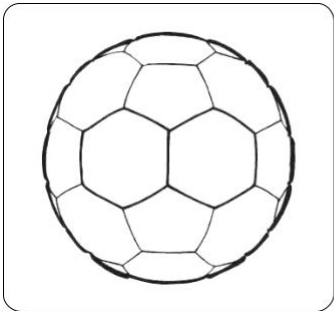
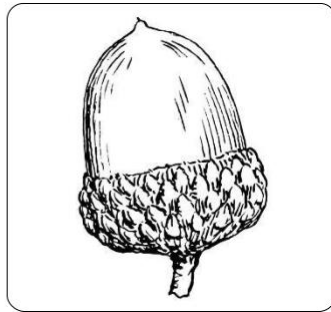
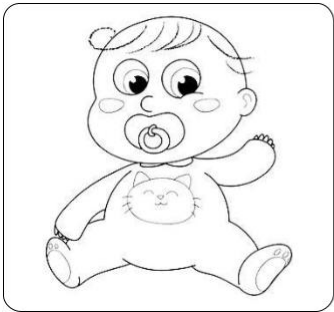
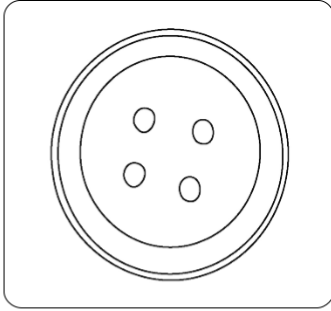
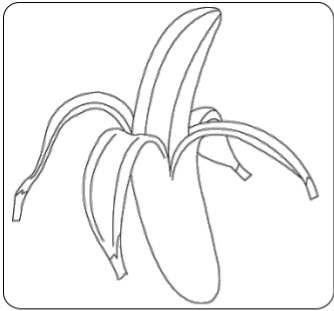

baú

tábua

boné

boi

bola

lobo

bigode

bebé

banana

botão

bota

bolota

14 DATA ___/___/___



Escreve as palavras que correspondem às imagens. Pinta.

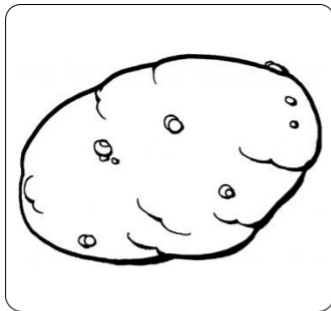
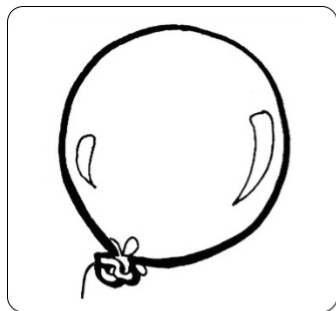

bonec
a

boca

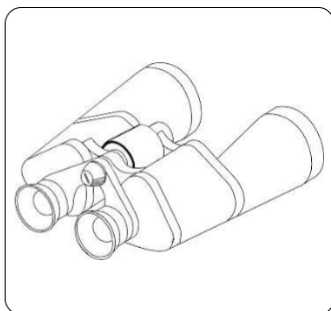
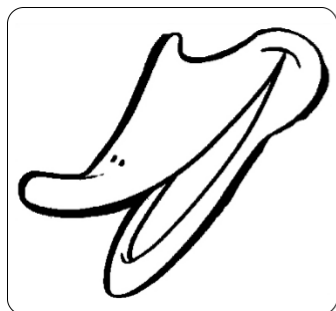

baleia

bule

balão

batido

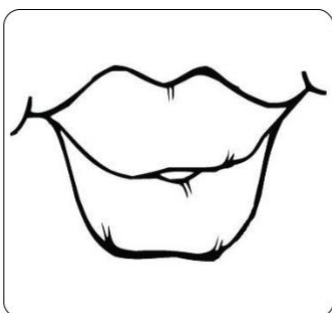
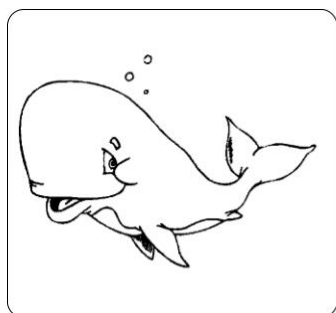

nabo

batata

bolo

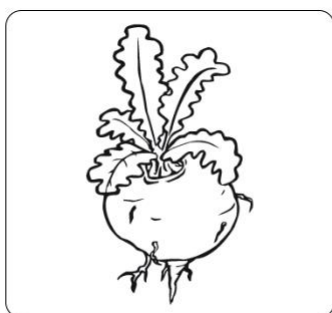

bico

babete